

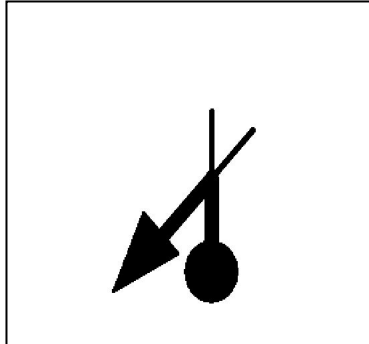

Herve Moto Rétro Club

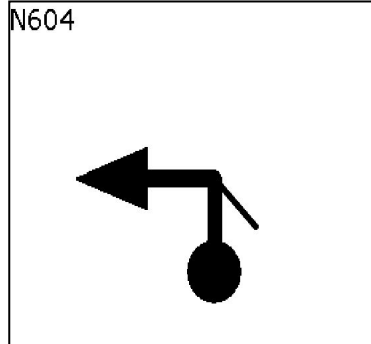

2,7 | 4 | 3,4



4,0 | 8 | 11,0

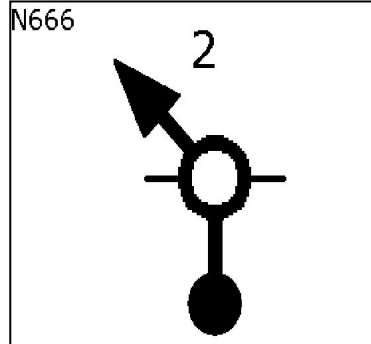

1,6 | 12 | 19,3



10,5 | 16 | 51,4

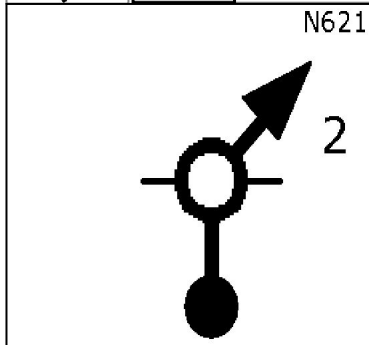

0,7 | 3 | 0,7

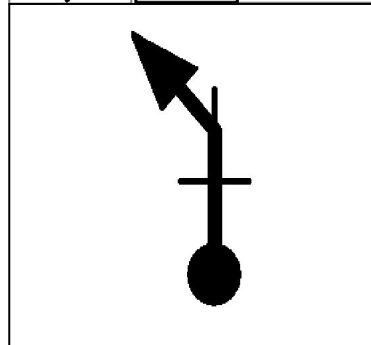

0,0 | 7 | 7,0

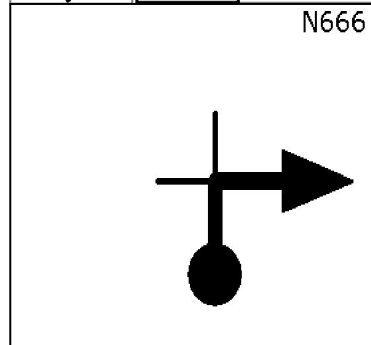

5,4 | 11 | 17,7

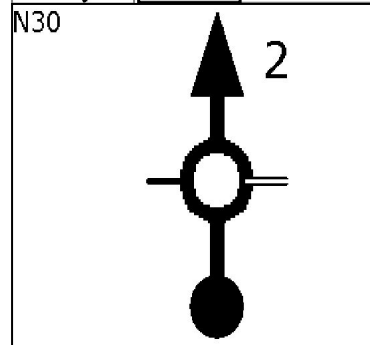

12,6 | 15 | 40,9

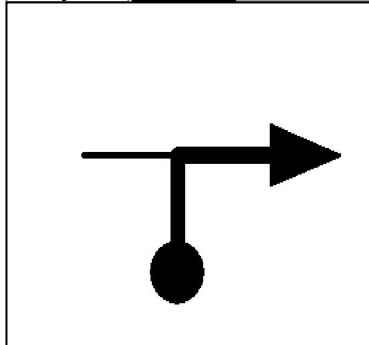

0,0 | 2 | 0,0

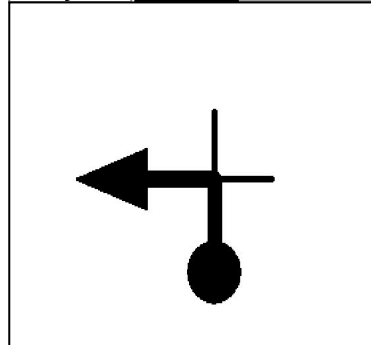

2,6 | 6 | 7,0

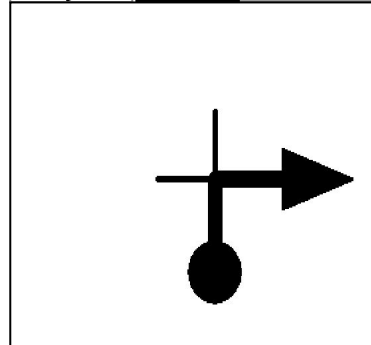

0,1 | 10 | 12,3

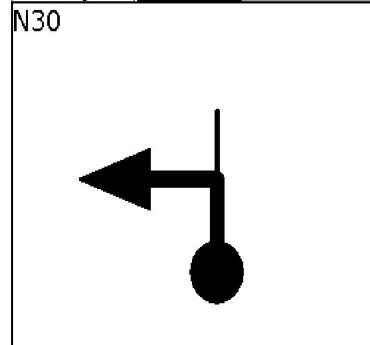

2,4 | 14 | 28,3

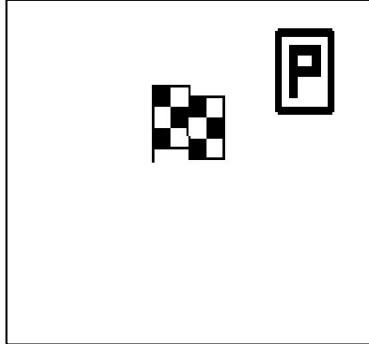

0,0 | 1 | 0,0

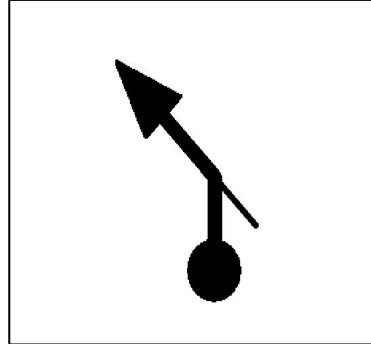

1,0 | 5 | 4,4

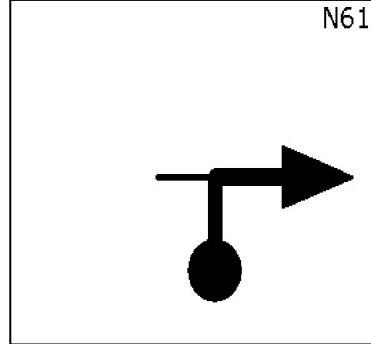



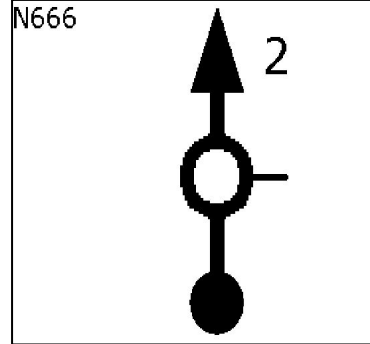



1,2 | 9 | 12,2

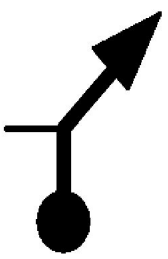

6,6 | 13 | 25,9

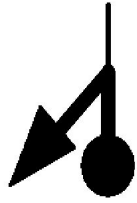

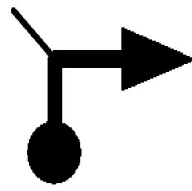
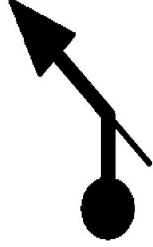
Herve Moto Rétro Club

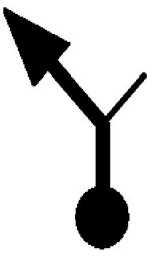
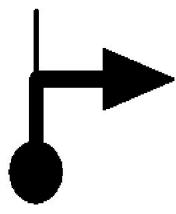
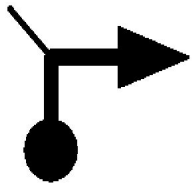
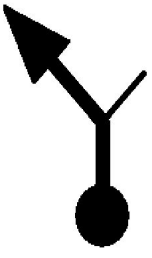
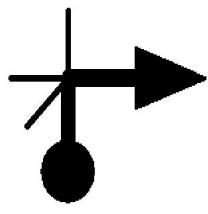
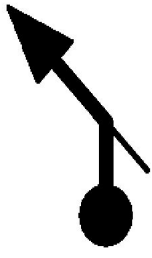
<p>CR333</p> 			<p>CR319</p> 
<p>10,7 4 35,3</p>	<p>0,1 8 36,9</p>	<p>1,5 12 47,7</p>	<p>1,9 16 50,5</p>
<p>P19</p> 	<p>CR332</p> 		
<p>16,9 3 24,6</p>	<p>1,0 7 36,8</p>	<p>3,7 11 46,2</p>	<p>0,6 15 48,6</p>
<p>N89</p>  <p>2</p>		<p>N12</p> 	
<p>7,7 2 7,7</p>	<p>0,4 6 35,8</p>	<p>4,6 10 42,5</p>	<p>0,2 14 48,0</p>
<p>DEBUT</p>	<p>CR333</p> 	<p>N12</p> 	<p>CR329</p> 
<p>0,0 1 0,0</p>	<p>0,1 5 35,4</p>	<p>1,0 9 37,9</p>	<p>0,1 13 47,8</p>





Herve Moto Rétro Club

	KNAUF Route de Bastogne 19 L-9638 POMMERLOC FIN		
0,7 20 53,7	0,5 24 55,0		
	N15 3 		
0,8 19 53,0	0,1 23 54,5		
1,0 18 52,2	0,2 22 54,4		
0,7 17 51,2	0,5 21 54,2		

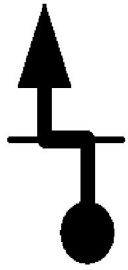
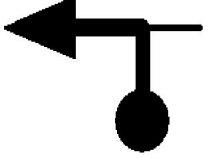
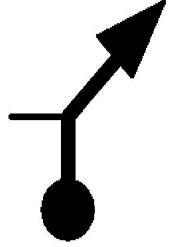

Herve Moto Rétro Club

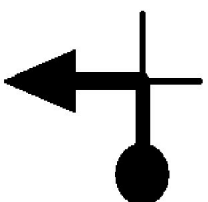
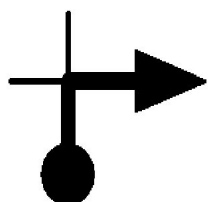
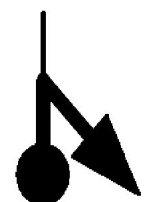
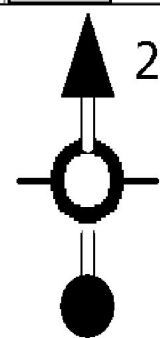
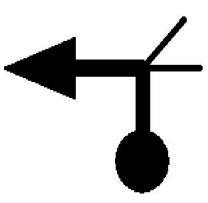
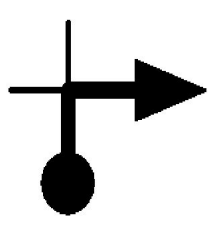
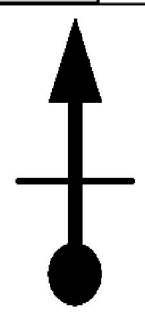
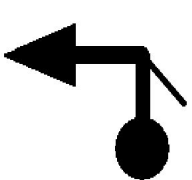
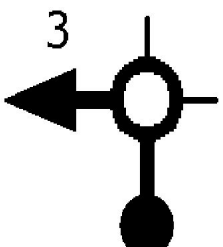
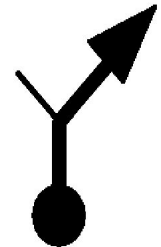
<p>N15</p> 	<p>N12</p> 		
<p>0,2 3 1,5</p>	<p>0,6 7 7,3</p>	<p>0,7 11 19,1</p>	<p>0,0 15 19,8</p>
		<p>CR362</p> 	<p>CR362</p> 
<p>1,2 2 1,3</p>	<p>0,0 6 6,7</p>	<p>0,1 10 18,4</p>	<p>0,5 14 19,8</p>
			<p>CR362</p> 
<p>0,1 1 0,1</p>	<p>5,2 5 6,7</p>	<p>3,4 9 18,3</p>	<p>0,2 13 19,3</p>
<p>DEBUT</p>		<p>3</p> 	<p>CR362</p> 
<p>0,0 0,1 0,0</p>	<p>0,0 4 1,5</p>	<p>7,6 8 14,9</p>	<p>0,0 12 19,1</p>



Herve Moto Rétro Club

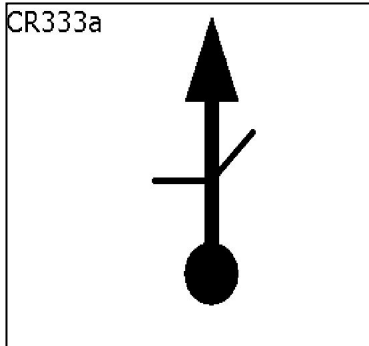

0,2 | 19 | 20,6

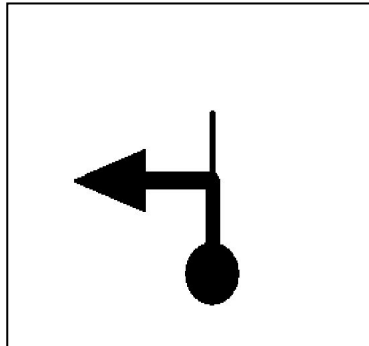

0,7 | 23 | 23,6

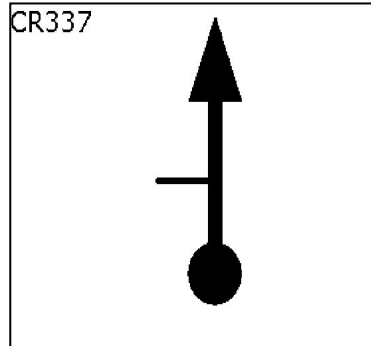

1,5 | 27 | 27,1

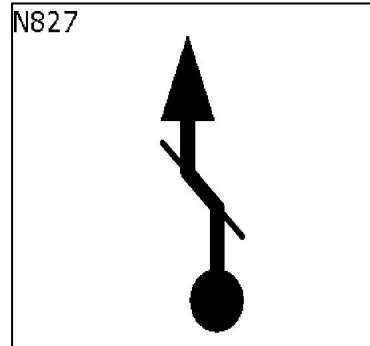

2,8 | 31 | 36,9

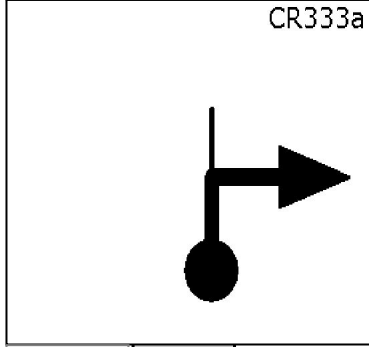

0,2 | 18 | 20,4

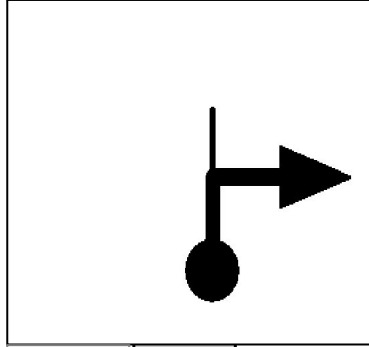

2,1 | 22 | 22,9

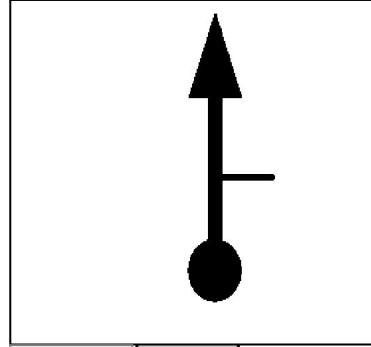

0,4 | 26 | 25,6

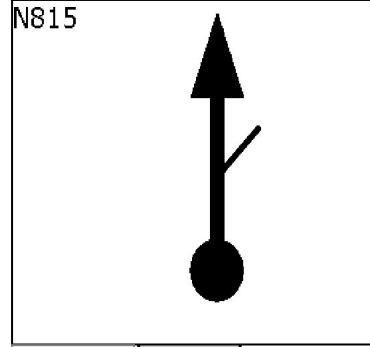

0,1 | 30 | 34,1

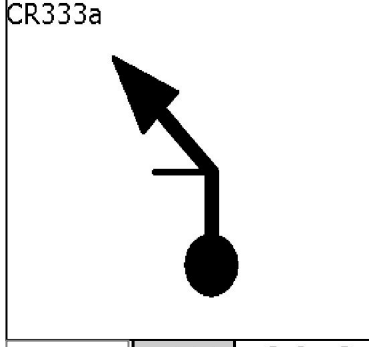

0,2 | 17 | 20,2

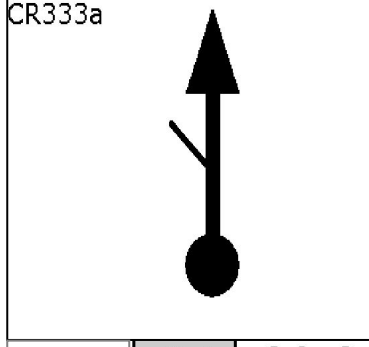

0,1 | 21 | 20,8

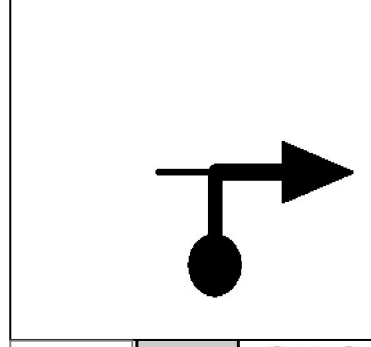

0,7 | 25 | 25,2

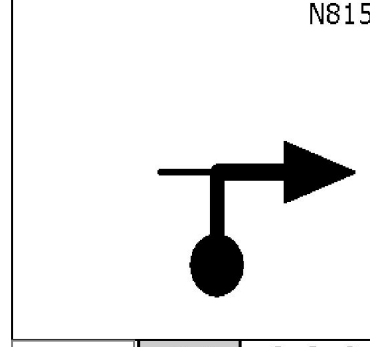

6,1 | 29 | 34,0

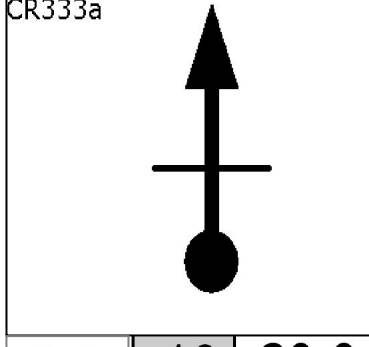

0,2 | 16 | 20,0

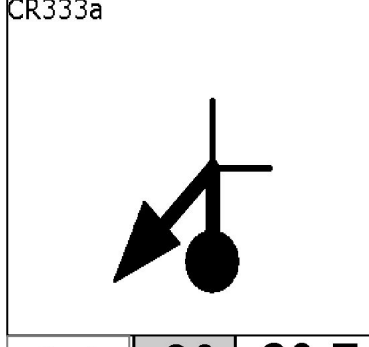

0,1 | 20 | 20,7

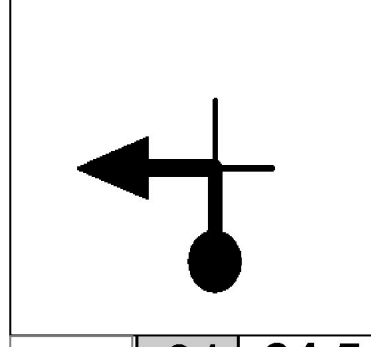



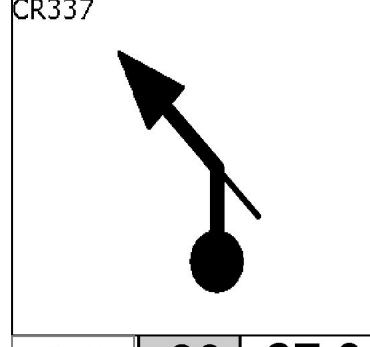





0,9 | 24 | 24,5



0,8 | 28 | 27,9

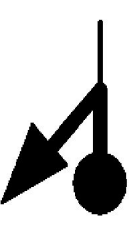
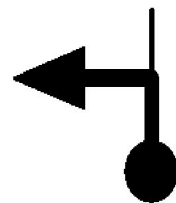

Herve Moto Rétro Club

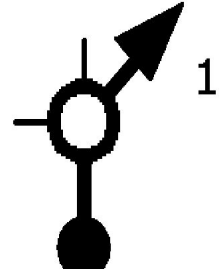
<p>N827</p> 	<p>N823</p> 		
<p>0,1 35 39,6</p>	<p>0,1 39 45,8</p>	<p> </p>	<p> </p>
	<p>N823</p> 		
<p>0,4 34 39,5</p>	<p>5,0 38 45,7</p>	<p> </p>	<p> </p>
<p>N827</p> 	<p>N827</p> 		
<p>0,6 33 39,1</p>	<p>0,2 37 40,7</p>	<p>0,4 41 53,0</p>	<p> </p>
<p>N827</p> 	<p>N827</p> 	<p>N823</p> 	
<p>1,6 32 38,5</p>	<p>0,9 36 40,5</p>	<p>6,8 40 52,6</p>	<p> </p>







Herve Moto Rétro Club

	N66 	N66 	
5,3 3 6,1	2,2 7 16,5	0,2 11 17,7	0,2 15 29,4
N822 	N651 		
0,5 2 0,8	4,5 6 14,3	0,4 10 17,5	3,5 14 29,2
N823 			
0,3 1 0,3	2,7 5 9,8	0,1 9 17,1	2,4 13 25,7
DEBUT			
0,0 0,1 0,0	1,0 4 7,1	0,5 8 17,0	5,6 12 23,3

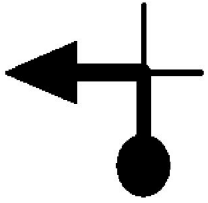
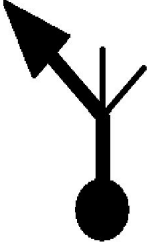
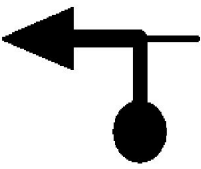
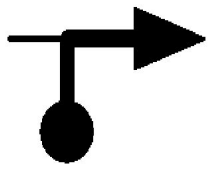
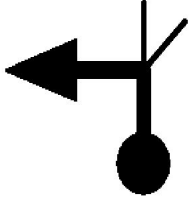
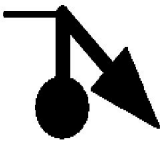
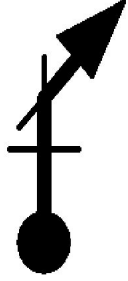
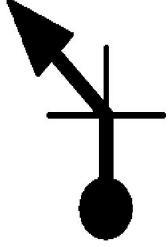
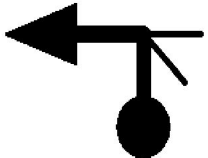
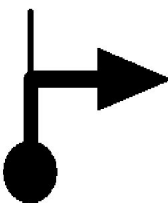
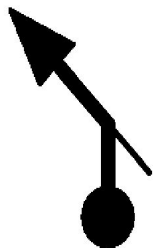
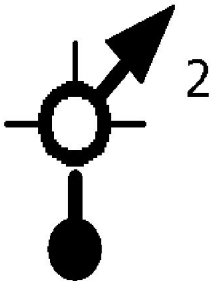
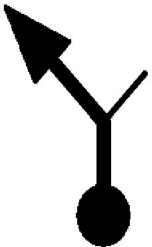

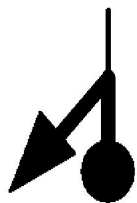
Herve Moto Rétro Club

<p>N633</p>  <p>0,3 19 32,9</p>	<p>N606</p>  <p>6,7 23 43,5</p>	<p>N62</p>  <p>3,5 27 50,8</p>	<p>N690</p>  <p>3,5 31 57,3</p>
<p>N633</p>  <p>0,2 18 32,6</p>	<p>N606</p>  <p>0,0 22 36,8</p>	 <p>0,9 26 47,3</p>	<p>N690</p>  <p>0,1 30 53,8</p>
<p>N633</p>  <p>0,1 17 32,4</p>	 <p>0,7 21 36,8</p>	 <p>0,0 25 46,4</p>	<p>N690</p>  <p>0,9 29 53,7</p>
 <p>2,9 16 32,3</p>	<p>N606</p>  <p>3,2 20 36,1</p>	 <p>2,9 24 46,4</p>	<p>N690</p>  <p>2,0 28 52,8</p>



Herve Moto Rétro Club

		 N621	
0,8 35 60,1	0,1 39 63,6	1,1 43 68,4	
 3			
0,6 34 59,3	3,3 38 63,5	1,3 42 67,3	
 4			
0,4 33 58,7	0,0 37 60,2	0,9 41 66,0	0,8 45 71,8
 N61			 2 N3
1,0 32 58,3	0,1 36 60,2	1,5 40 65,1	2,6 44 71,0